

Magnetic markers

The cleaning process requires magnetic position markers. These position markers (which can be S or U shaped) are placed in a brackets, mounted on the house equipment before the cleaning process takes place. The robot reaches the markers during the cleaning process and position information is transferred to the computer. Different shapes of the markers are necessary depending on the width of the aisle and height of the walls in the aisle (see table below).

More information on [how to use the markers can be found via this link](#).

Types

MAGNETIC MARKER TYPES	PART NO	DxWxH [mm]	AISLE WIDTH	AISLE WALL HEIGHT	DESCRIPTION
EVO marker S form short	32026	25×25×250	Up to 80cm.	74cm or lower.	Installed standing in bracket where aisle width is limited.
EVO marker S form	32030	130×25×250	From 81cm or wider.	74cm or lower.	Installed standing in bracket.
EVO marker U form	32040	130×25×210	From 81cm or wider.	75cm or higher.	Installed hanging in bracket.
FITTINGS					
Marker bracket	30000	1.5x58x58			Mounted permanently with screws or clamps in the aisle.
Tube clamp 35mm	30010	Ø35			For simple mounting of the marker brackets if there are usable pipes in the interior.
Tube clamp 45mm	30020	Ø45			For simple mounting of the marker brackets if there are usable pipes in the interior.

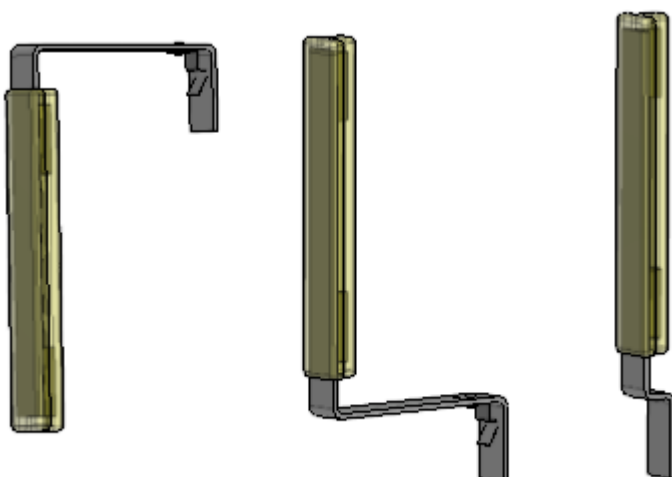

EVO marker U form, S form and S form short.

Marker placement examples

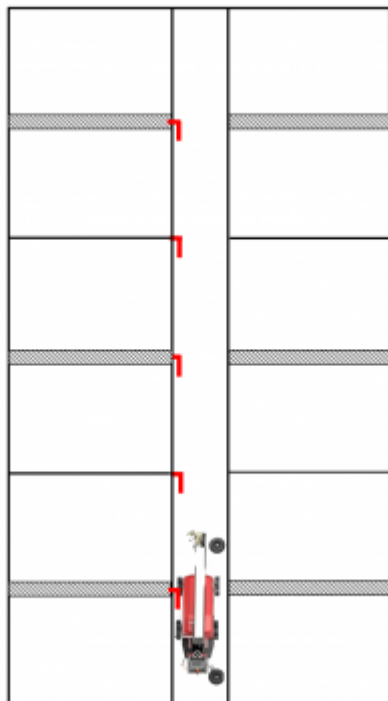

From:

<https://wiki.envirologic.se/> - **Envirologic Support Wiki**

Permanent link:

https://wiki.envirologic.se/doku.php/parts:magnetic_markers?rev=1641391066

Last update: **2022/01/05 05:57**

