

1101100-M / Water valve

The water valve can get blocked/clogged with particles if the incoming water is dirty. Always use a [water filter](#) on the incoming water by the [high-pressure washer](#).

Link: [How to clean the water valve](#).

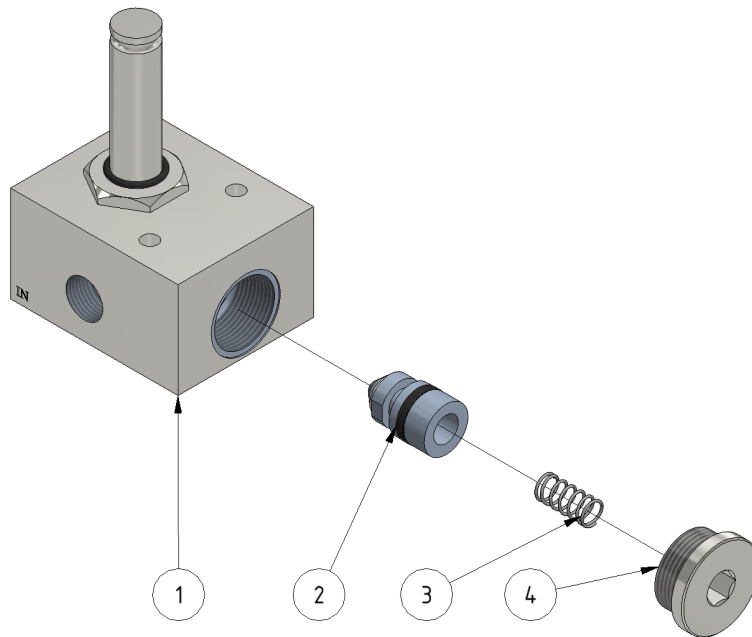

ITEM	DESCRIPTION	PART NUMBER	QTY
1	Magnetic valve	1101100	1
2	Plunge	969202	1
3	Spring	969203	1
4	Plug	969204	1

From:
<https://wiki.envirologic.se/> - **Envirologic Support Wiki**

Permanent link:
<https://wiki.envirologic.se/doku.php/service:spl:1101100-m?rev=1601009356>

Last update: **2020/09/24 21:49**

