

Water valve

Part number: 1101100-F

Part of [EVO Cleaner assembly 2 - 1109502](#)

The water valve can get blocked/clogged with particles if the incoming water is dirty. Always use a [water filter](#) on the incoming water by the [high-pressure washer](#).

Link: [How to clean the water valve.](#)

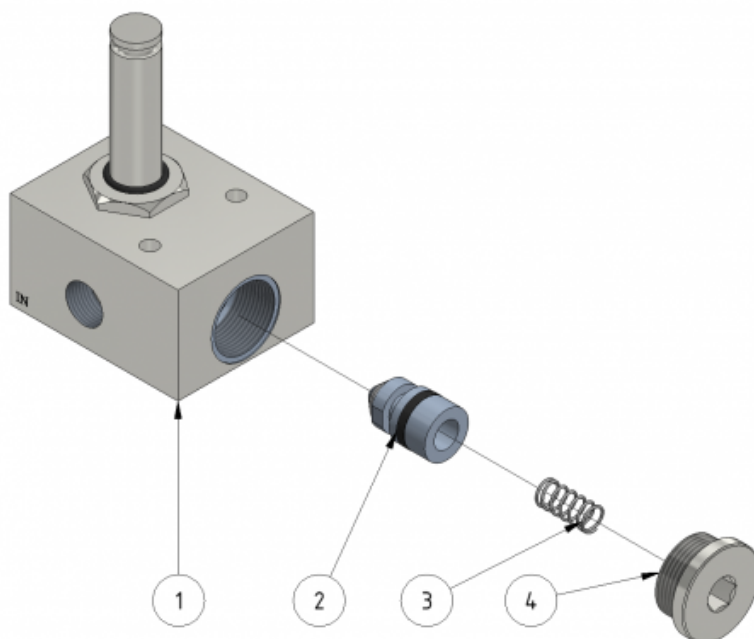

ITEM	DESCRIPTION	PART NUMBER	QTY
1	Magnetic valve	1101100	1
2	Plunge	969202	1
3	Spring	969203	1
4	Plug	969204	1

From: <https://wiki.envirologic.se/> - **Envirologic Support Wiki**

Permanent link: <https://wiki.envirologic.se/doku.php/service:spl:1101100-m?rev=1699212471>

Last update: **2023/11/05 11:27**

