

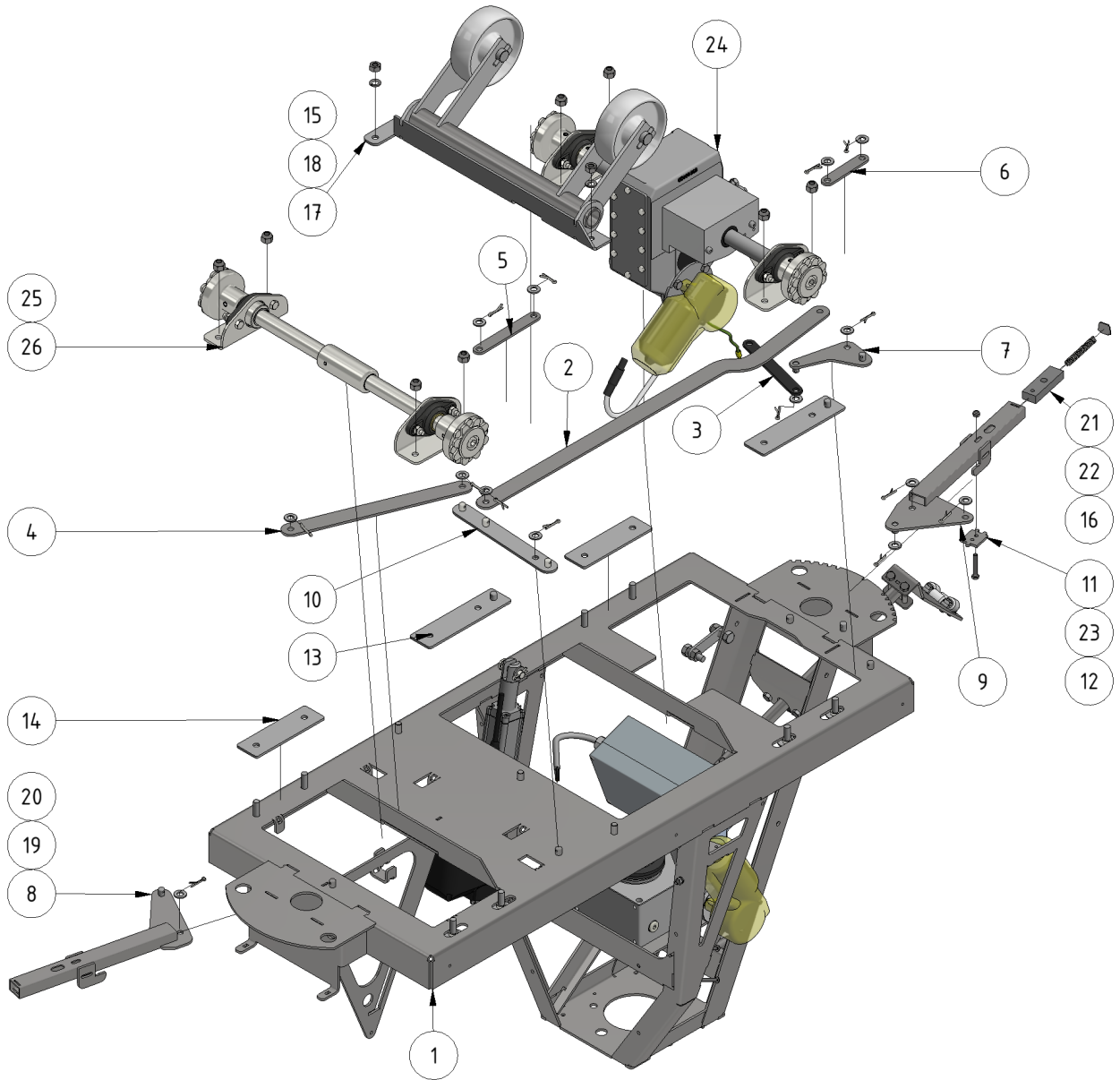

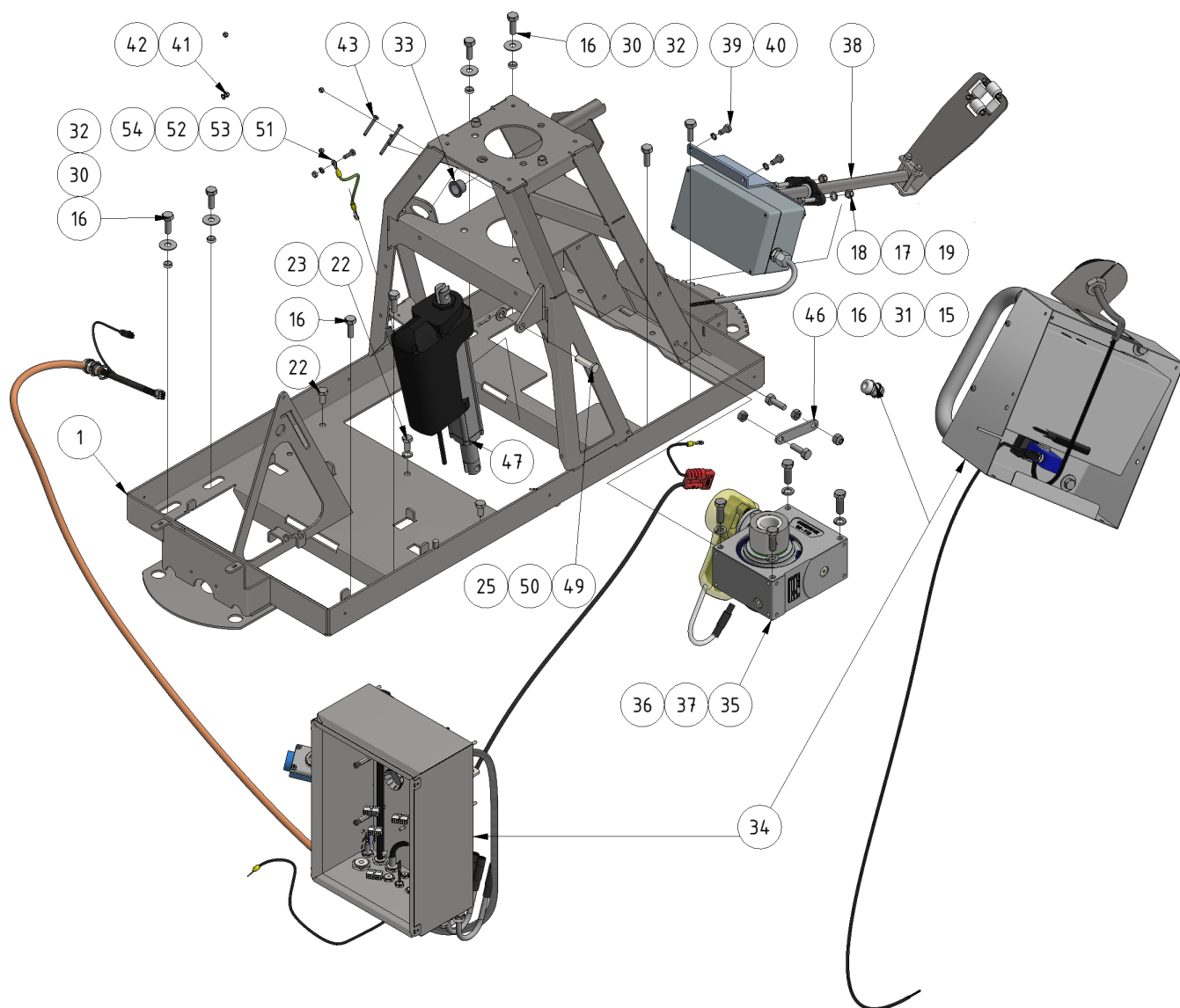



EVO Cleaner assembly 1109501

Part of [EVO Cleaner assembly 2 - 1109502](#)





ITEM	DESCRIPTION	PART NUMBER	QTY
1	Chassis	1109201	1
2	Long rod	409211	1
3	Short rear rod	409212	1
4	Long front rod	409213	1
5	Short front rod	409215	1
6	Short rear rod	409216	1
7	Rear link	1109202	1
8	Front rod	1109203	1
9	Rear rod	1109204	1
10	Front link	1109205	1
11	Lock	409219	1
12	Nut M6 Nyloc	941009	1
13	Plate with pin	1101030	2
14	Plate	401059	2
15	Nut M10	941025	4
16	Plate	159201	1
17	Electric transport wheel assembly	 1107030M	1

ITEM	DESCRIPTION	PART NUMBER	QTY
18	Spring washer M10	941105	3
19	Washer M10	941022	14
20	Split pin 3.2 x 25	941049	16
21	Block	1409214	1
22	Spring	909002	1
23	Screw M6 x 40	947074	1
24	Drive axle assembly	 1109523	1
25	Nut M10 Nyloc	941073	9
26	Front wheel axle	 1107041	1
30	Washer M10, large	941043	4
31	Nut M10 Nyloc	941073	9
32	Spacer	701025	4
33	Bearing GFM-2023-16	909203	1
34	Junction box assembly	 1109529	1
35	Gearbox tower assembly	 1109524	1
36	Screw M12 x 35	941037	4
37	Spring washer M12	941036	4
38	Hose spreader assembly	 1109520	1
39	M8 x 16	941101	2
40	Spring washer M8	941088	2
41	Nut M5 Nyloc	941064	4
42	Washer M5 teeth	941087	1
43	Screw M5 x 40	941034	3
46	Short rod	409224	1
47	Actuator LA36	1101312	1
49	Pin 12 mm	707019	2
50	Washer M12	941030	2
51	Ground cable	901147	1
52	Nut M6	941002	1
53	Spring Washer M6	941045	1
54	Screw M6 x 20	941103	1

From:
<https://wiki.envirologic.se/> - **Envirologic Support Wiki**

Permanent link:
<https://wiki.envirologic.se/doku.php/service:spl:1109501-1?rev=1601212462>

Last update: **2020/09/27 06:14**

