

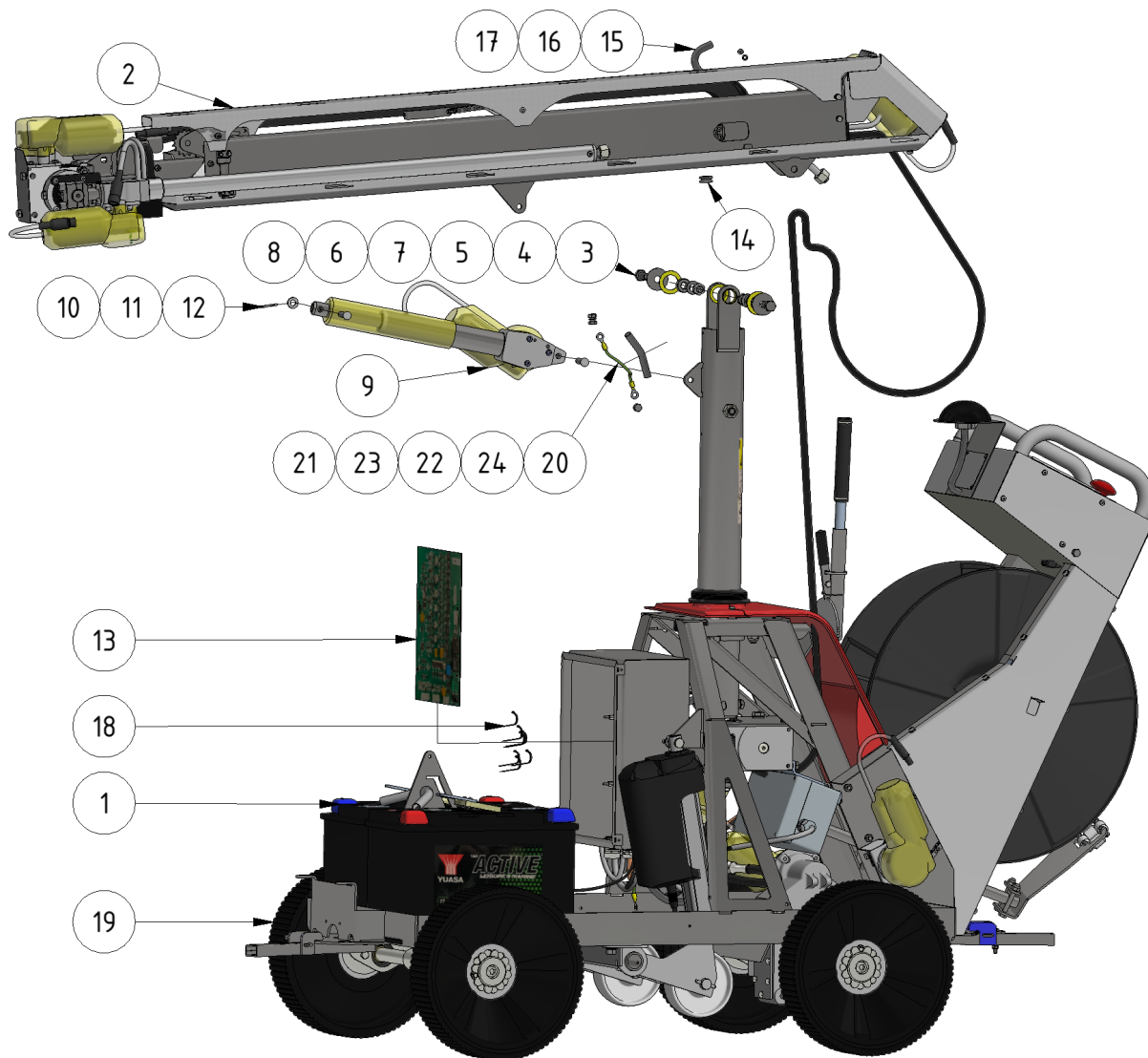

EVO Cleaner assembly 3 - 1109503

Part of [EVO Cleaner assembly 4 - 1109500](#)



ITEM	DESCRIPTION	PART NUMBER	QTY
1	EVO Cleaner assembly 2	1109502	1
2	Telescope assembly	1109708	1
3	Screw M12 x 35	941037	2
4	Washer M12 large	201004	2
5	Washer QTM-2842-015	901039	2
6	Washer M12	941030	2
7	Ring	701006	2
8	Nut M12, Nyloc	941071	2
9	Actuator	909243	1
10	Pin	904000	2
11	Washer M10	941022	2

ITEM	DESCRIPTION	PART NUMBER	QTY
12	Split pin 3,2 x 25	941049	2
13	Circuit board	909054	1
14	Cable entry, rubber	901102-1	1
15	Protection hose 0,6 m	981047	1
16	Screw M5 x 8	941035	1
17	Washer M5 teeth	941087	1
18	Cable tie 300 x 4,8	51526	7
19	Flexi-wheel 70	977030	4
20	Ground cable	 901145	1
21	Screw M8 x 10	941080-1	2
22	Nut M8	941017	1
23	Spring washer M8	941088	2
24	Protection hose 0,6 m	981047	1

From:

<https://wiki.envirologic.se/> - **Envirologic Support Wiki**

Permanent link:

<https://wiki.envirologic.se/doku.php/service:spl:1109503?rev=1601372623>

Last update: **2020/09/29 02:43**

