

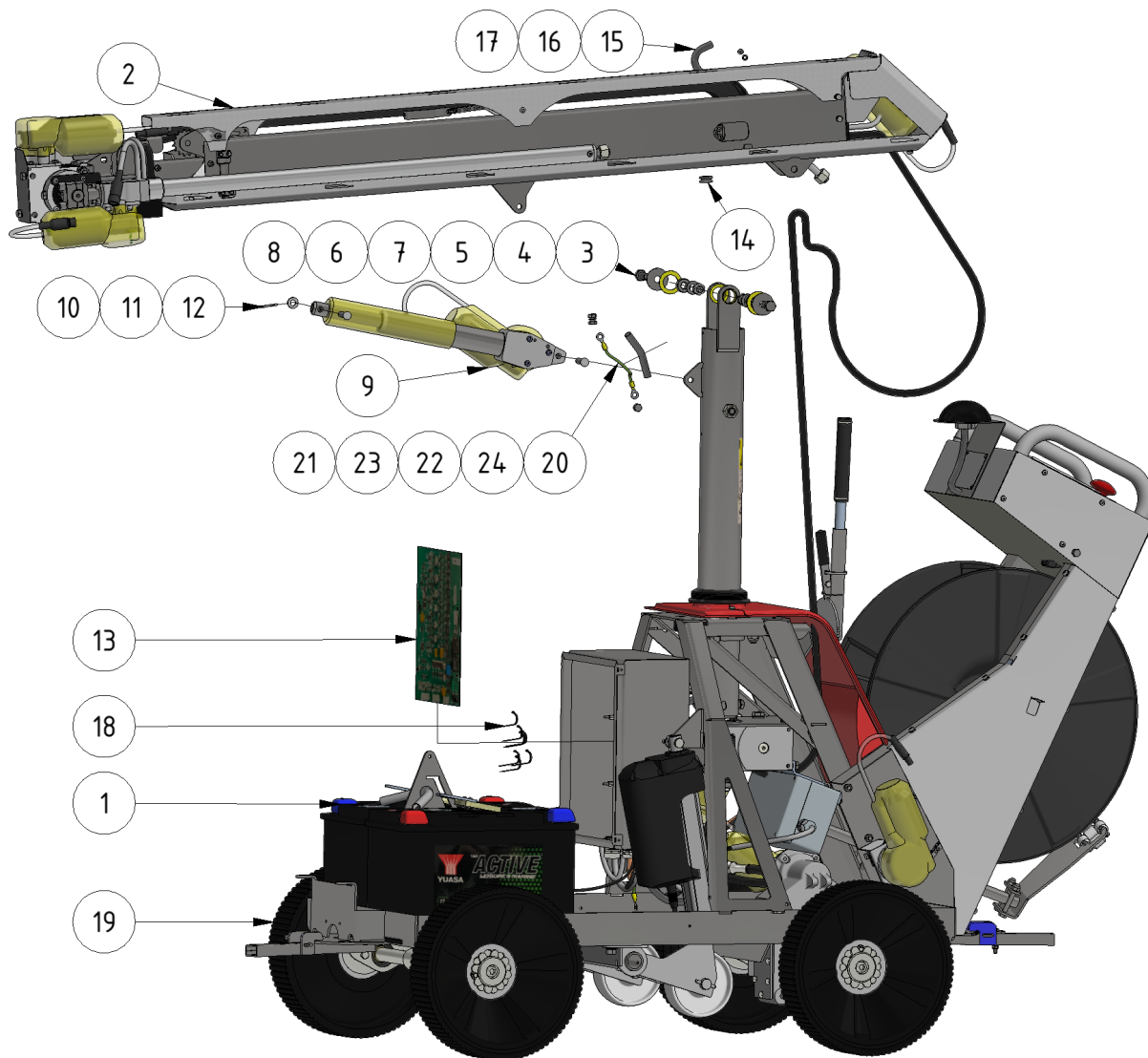

EVO Cleaner assembly 3 - 1109503

Part of [EVO Cleaner assembly 4 - 1109500](#)



| ITEM | DESCRIPTION | PART NUMBER | QTY |
|------|------------------------|-------------------------|-----|
| 1 | EVO Cleaner assembly 2 | 1109502 | 1 |
| 2 | Telescope assembly | 1109708 | 1 |
| 3 | Screw M12 x 35 | 941037 | 2 |
| 4 | Washer M12 large | 201004 | 2 |
| 5 | Washer | 901039 | 2 |
| 6 | Washer M12 | 941030 | 2 |
| 7 | Ring | 701006 | 2 |
| 8 | Nut M12, Nyloc | 941071 | 2 |
| 9 | Actuator | 909248 | 1 |
| 10 | Pin | 904000 | 2 |
| 11 | Washer M10 | 941022 | 2 |

| ITEM | DESCRIPTION | PART NUMBER | QTY |
|------|--------------------------------|--|-----|
| 12 | Split pin 3,2 x 25 | 941049 | 2 |
| 13 | Circuit board | 909054 | 1 |
| 14 | Cable entry, rubber | 901102 | 1 |
| 15 | Protection hose 0,6 m | 981047 | 1 |
| 16 | Screw M5 x 8 | 941035 | 1 |
| 17 | Washer M5 teeth | 941087 | 1 |
| 18 | Cable tie 300 x 4,8 | 51526 | 7 |
| 19 | Flexi-wheel 70 |  977030 | 4 |
| 20 | Ground cable | 901145 | 1 |
| 21 | Screw M8 x 10 | 941080-1 | 2 |
| 22 | Nut M8 | 941017 | 1 |
| 23 | Spring washer M8 | 941088 | 2 |
| 24 | Protection hose 0,6 m | 981047 | 1 |

From:
<https://wiki.envirologic.se/> - **Envirologic Support Wiki**

Permanent link:
<https://wiki.envirologic.se/doku.php/service:spl:1109503?rev=1712133795>

Last update: **2024/04/03 01:43**

