

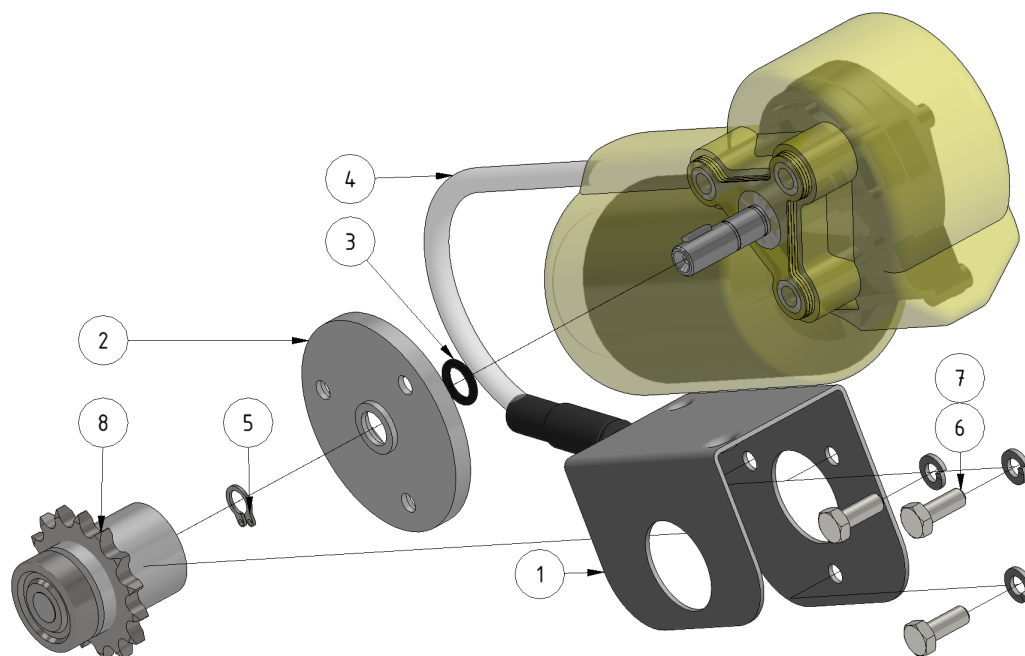

# Hose reel drive unit

Part number: 1109515

Part of [EVO Cleaner assembly 2 - 1109502](#)



ITEM	DESCRIPTION	PART NUMBER	QTY
1	Joint motor	159204	1
2	Motor sealer	909701	1
3	O-ring 10 x 3.5	969001	1
4	Motor 220 rpm, gen. 2 	<a href="#">909241</a>	1
5	Lock ring SGA 10	941041	1
6	Screw M6 x 16	941006	3
7	Spring Washer M6	941045	3
8	Drive axle 	<a href="#">1101124</a>	1

From: <https://wiki.envirologic.se/> - **Envirologic Support Wiki**

Permanent link: <https://wiki.envirologic.se/doku.php/service:spl:1109515-1?rev=1601280933>

Last update: **2020/09/28 01:15**

