

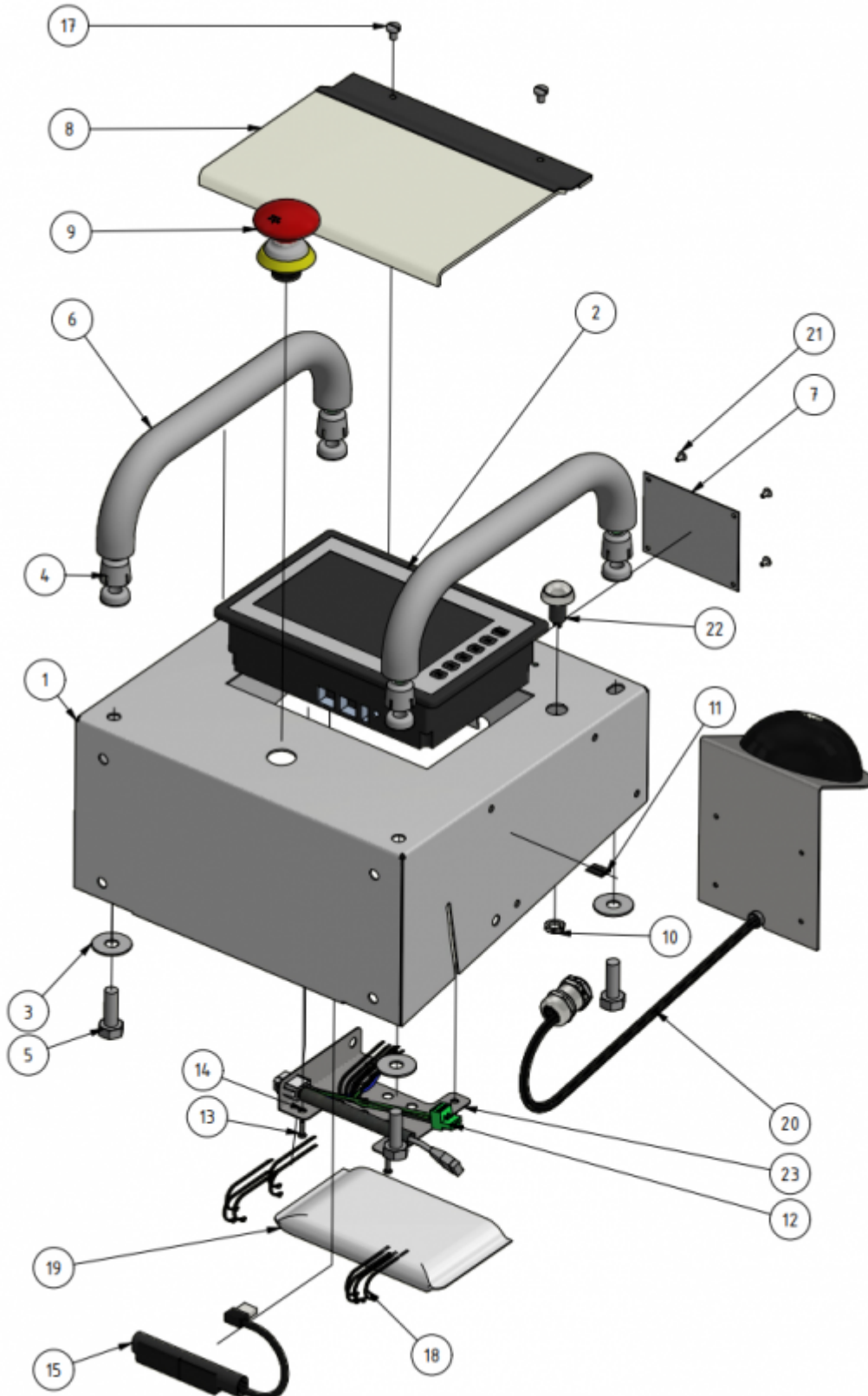

# Panel assembly

Part number: 1109516

Part of [Junction box assembly](#)



ITEM	DESCRIPTION	PART NUMBER	QTY
1	Top	159208	1
2	Display	989201	1
3	Washer M10, large	941043	4
4	Expander	709203+709204	4
5	M10 x 30	941024	4
6	Handle bar	809203	2
7	Machine specification sign	909239	1
8	Lid OP	1109518	1
9	Emergency stop button	989244	1
10	Nut On/Off button	984007	1
11	Micro-SD card 8GB	989202	1
12	OP cable	989248	1
13	Screw M3 x 12	949208	4
14	Washer M5 teeth	941087	1
15	USB assembly	 <a href="#">1109101</a>	1
16	Cable tie 300 x 4.8	51525	5
17	Screw M5 x 8	941035	2
18	Cable tie 300 x 4.8	5152	4
19	Dry-bag 125 g	907079	1
20	Antenna assembly	 <a href="#">1109103</a>	1
21	Blind rivet, 3 mm	931207	4
22	On/Off button	984007	1
23	Joint	109220	1

From:  
<https://wiki.envirologic.se/> - **Envirologic Support Wiki**

Permanent link:  
<https://wiki.envirologic.se/doku.php/service:spl:1109516-2?rev=1707990026>

Last update: **2024/02/15 01:40**

