

Switch holder

Part number: 1109519

Part of [EVO Cleaner assembly 2 - 1109502](#)

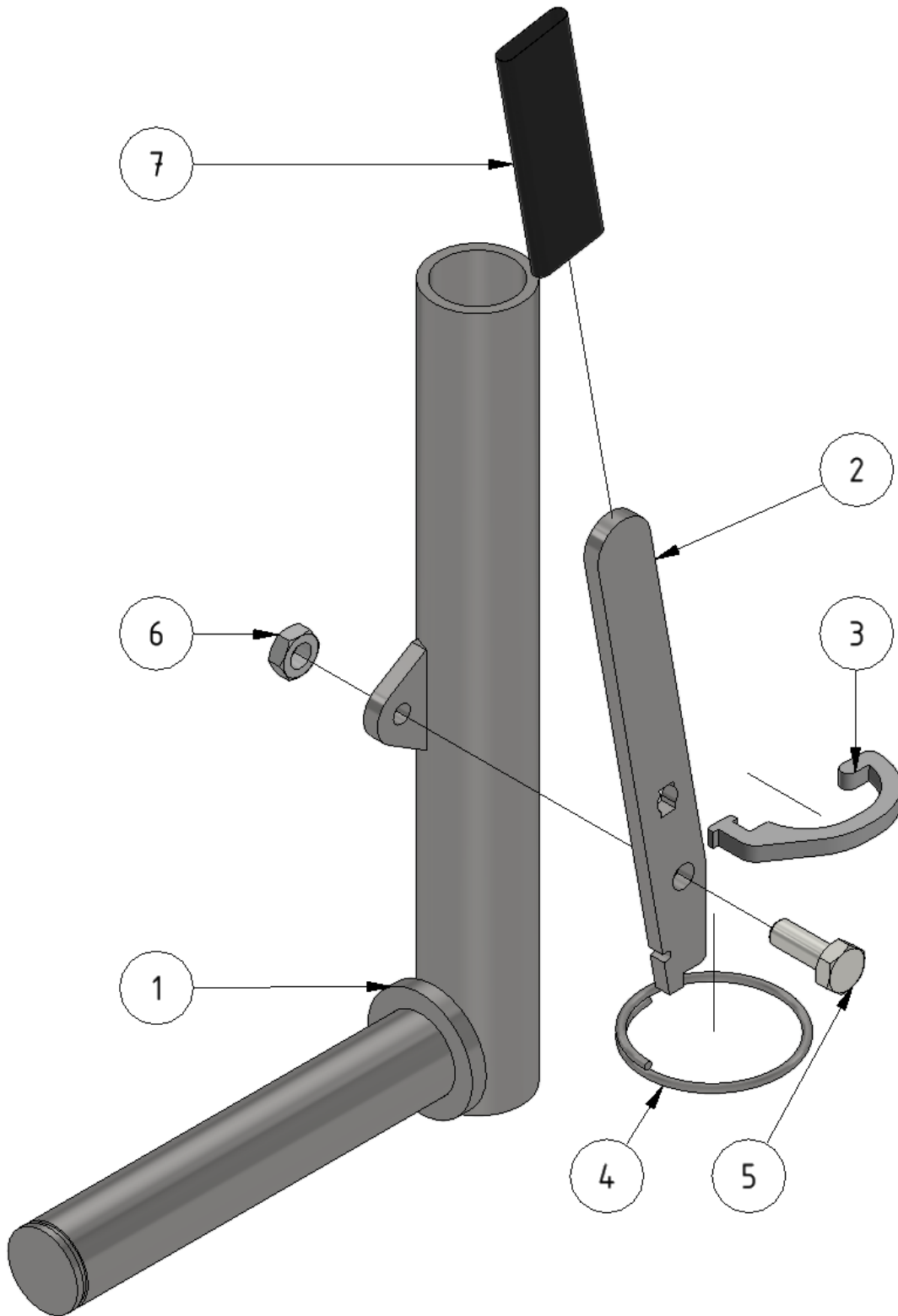

ITEM	DESCRIPTION	PART NUMBER	QTY
1	Holder	1109219	1
2	Handle	409232	1
3	Lock	409234	1
4	Spring	909208	1
5	Screw M6 x 16	941006	1
6	Nut M6	941002	1
7	Shrink tube	45519	1

From:
<https://wiki.envirologic.se/> - **Envirologic Support Wiki**

Permanent link:
<https://wiki.envirologic.se/doku.php/service:spl:1109519-1?rev=1601281110>

Last update: **2020/09/28 01:18**

