

# Drive axle assembly

Part of [EVO Cleaner assembly 1 - 1109501](#)

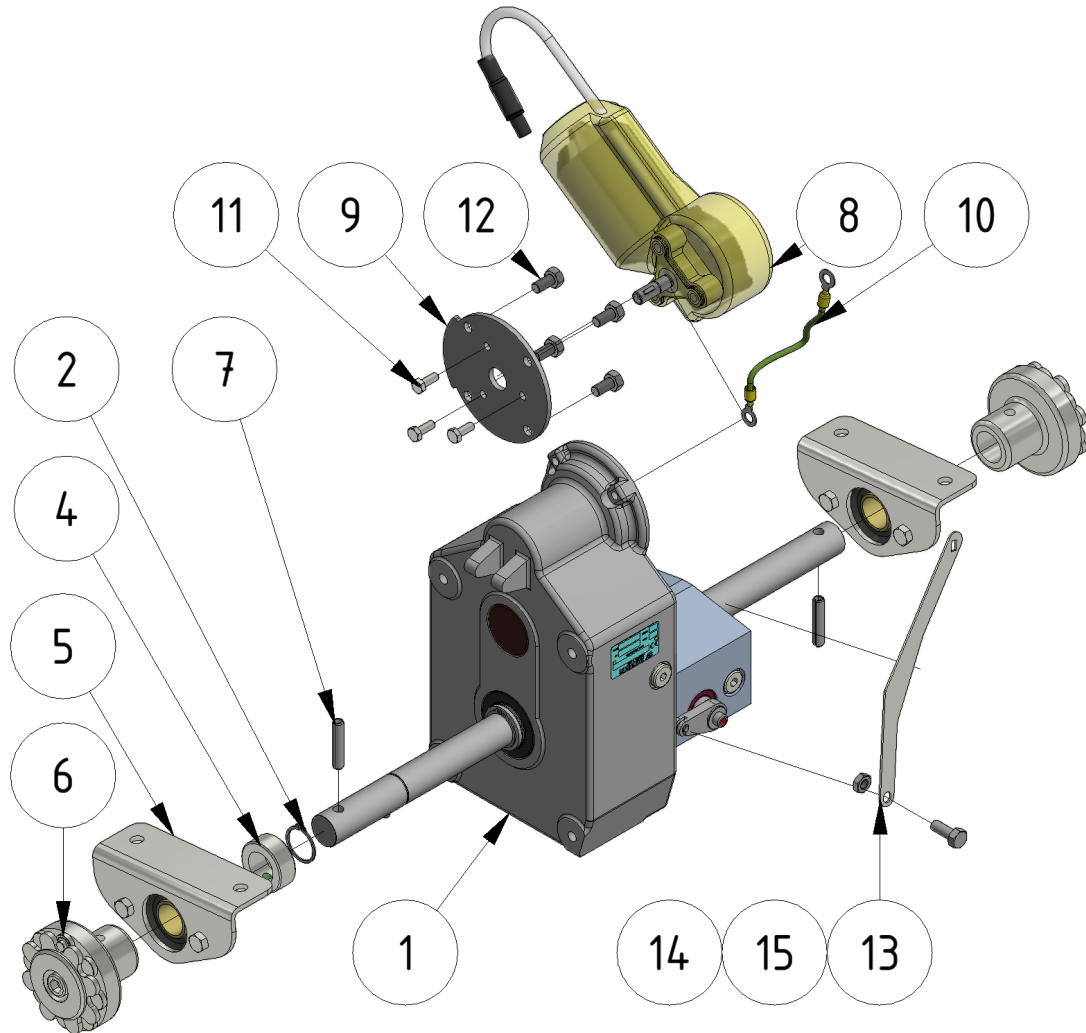

ITEM	DESCRIPTION	PART NUMBER	QTY
1	Gearbox	<a href="#">+ 93187752</a>	1
2	Lockring	941079	1
4	Stop ring 25 mm	931002	1
5	Wheel-bearing assembly	<a href="#">+ 1101199</a>	2
6	Wheel-hub	<a href="#">+ 1107040</a>	2
7	Pin 8 x 40	941063	2
8	Motor 220 rpm, gen.2	<a href="#">+ 909241</a>	1
9	Adapter	401058	1
10	Ground cable	<a href="#">+ 901145</a>	1

ITEM	DESCRIPTION	PART NUMBER	QTY
11	Screw M6 x 16	941006	3
12	M8 x 16	941101	4
13	Rod	159206	1
14	Screw M8 x 20	941019	1
15	Nut M8	941017	1

From:

<https://wiki.envirologic.se/> - **Envirologic Support Wiki**

Permanent link:

<https://wiki.envirologic.se/doku.php/service:spl:1109523-1?rev=1601208886>

Last update: **2020/09/27 05:14**

