

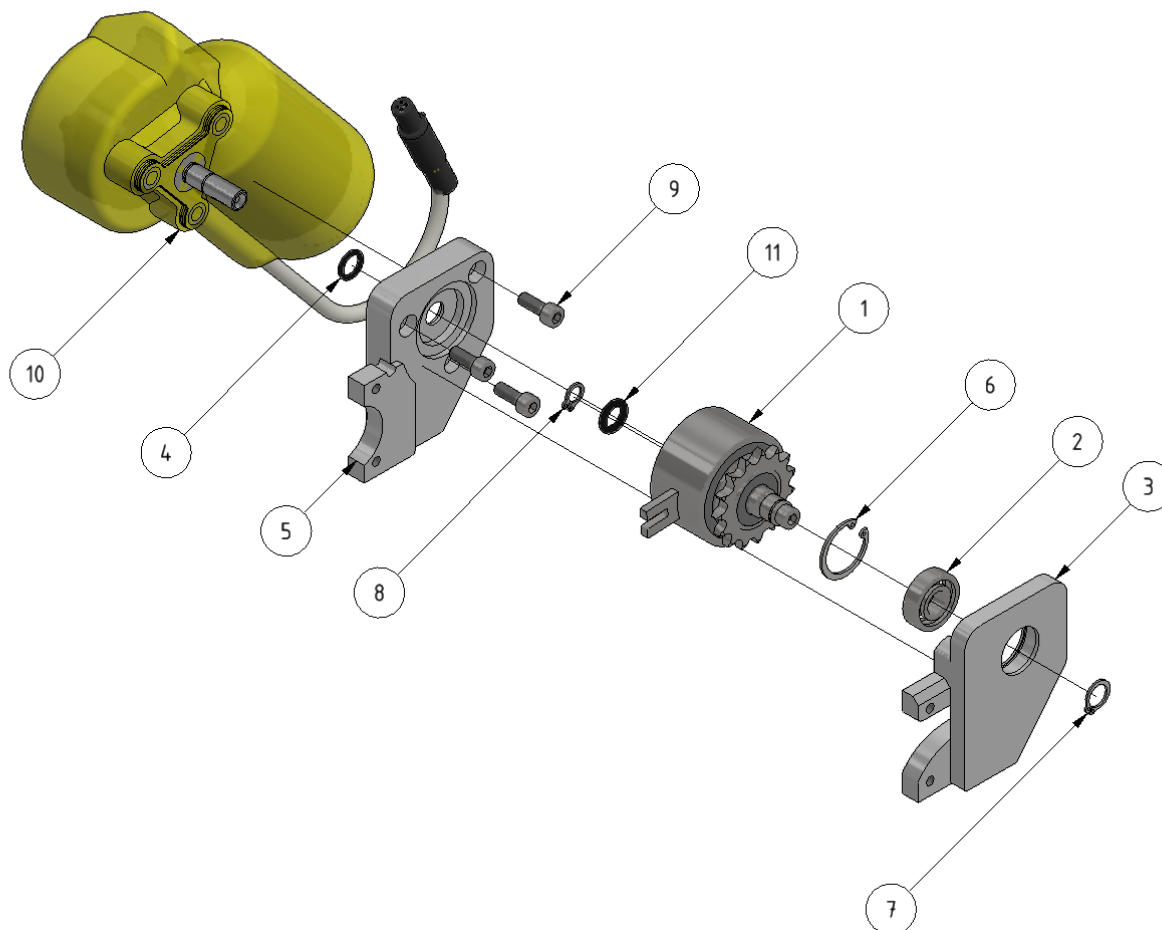

Drive unit telescope

Part number: 1109706

Part of [Telescope assembly](#)



ITEM	DESCRIPTION	PART NUMBER	QTY
1	Brake	1109705	1
2	Bearing 6001	931001	1
3	Left joint	709709	1
4	O-ring 10 x 2.5	969001	1
5	Right joint	709708	1
6	Lock ring SGH 28	949011	1
7	Lock ring SGA 12	949009	1
8	Lock ring SGA 10	941041	1
9	Insex M6 x 16	941100-1	3
10	Motor 70 rpm	 909245	1
11	O-ring	969002	1

From:

<https://wiki.envirologic.se/> - **Envirologic Support Wiki**

Permanent link:

<https://wiki.envirologic.se/doku.php/service:spl:1109706-1?rev=1712169093>

Last update: **2024/04/03 11:31**

