

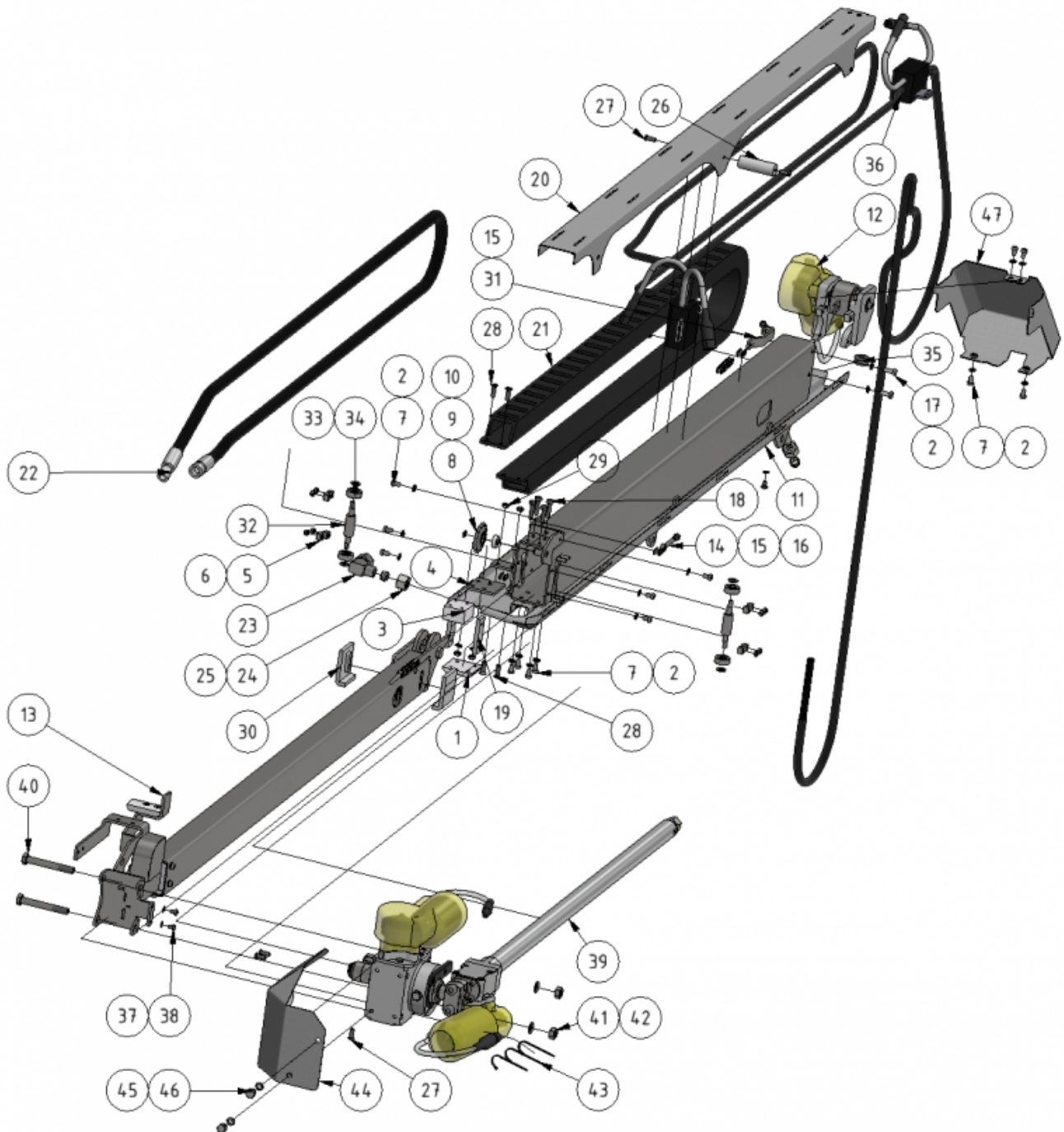





Telescope assembly

Part number: 1109708

Part of [EVO Cleaner assembly 3 - 1109503](#)



ITEM	DESCRIPTION	PART NUMBER	QTY
1	Wide sliding plate	1401003	1
2	Spring Washer M6	941045	22
3	Puck	1401007	1
4	Chain joint	1101028	1
5	Cover	701094	4

ITEM	DESCRIPTION	PART NUMBER	QTY
6	Nut M5 Nyloc	941064	8
7	Screw M6 x 10	941007	14
8	Spacer	1401012	1
9	Chain wheel	 1101163	1
10	Lock ring SGA 10	941041	1
11	Outer boom	1109605	1
12	Drive unit telescope	 1109706	1
13	Middle boom	 1109715	1
14	Clamp screw	941069	1
15	Nut M6 Nyloc	941009	2
16	Chain-lock 3/8	901104	2
17	Screw M6 x 16	941006	4
18	Screw M6 x 25	941005	4
19	Sliding plate, side	1409702	2
20	Telescope plate, upper	109704	1
21	Cable chain	901115	1
22	Hose	969022RF	1
23	Connector 90	964026RF	1
24	Nut 12L Stainless	961031RF	2
25	Sealing 12-LS Stainless	961032RF	2
26	Chain slider	1409708	1
27	Insex M6 x 16	949709	5
28	M6 x 18	941109	4
29	Nut M6	941002	4
30	Sliding plate, rear	1409709-2	2
31	Chain 121	 1109721	1
32	Axle	709710-2	2
33	Washer M8	941016	4
34	Shuttle wheel small	1109531	4
35	Cable entry, rubber	901102-1	1
36	Top cable harness	1109711	1
37	Washer M5 teeth	941087	3
38	Screw M5 x 8	941035	3
39	Arm assembly	 1109710	1
40	M10 x 80, screw	941058-1	2
41	Nut M10	941025	2
42	Spring washer M10	941105	2
43	Cable tie 300 x 4.8	51526	5
44	Cover	109702	1
45	Spring washer M8	941088	2
46	Screw M8 x 10	941080-1	2
47	Telescope cover, rear	159701-3	1

From:

<https://wiki.envirologic.se/> - **Envirologic Support Wiki**

Permanent link:

<https://wiki.envirologic.se/doku.php/service:spl:1109708-3?rev=1699211817>

Last update: **2023/11/05 11:16**

