

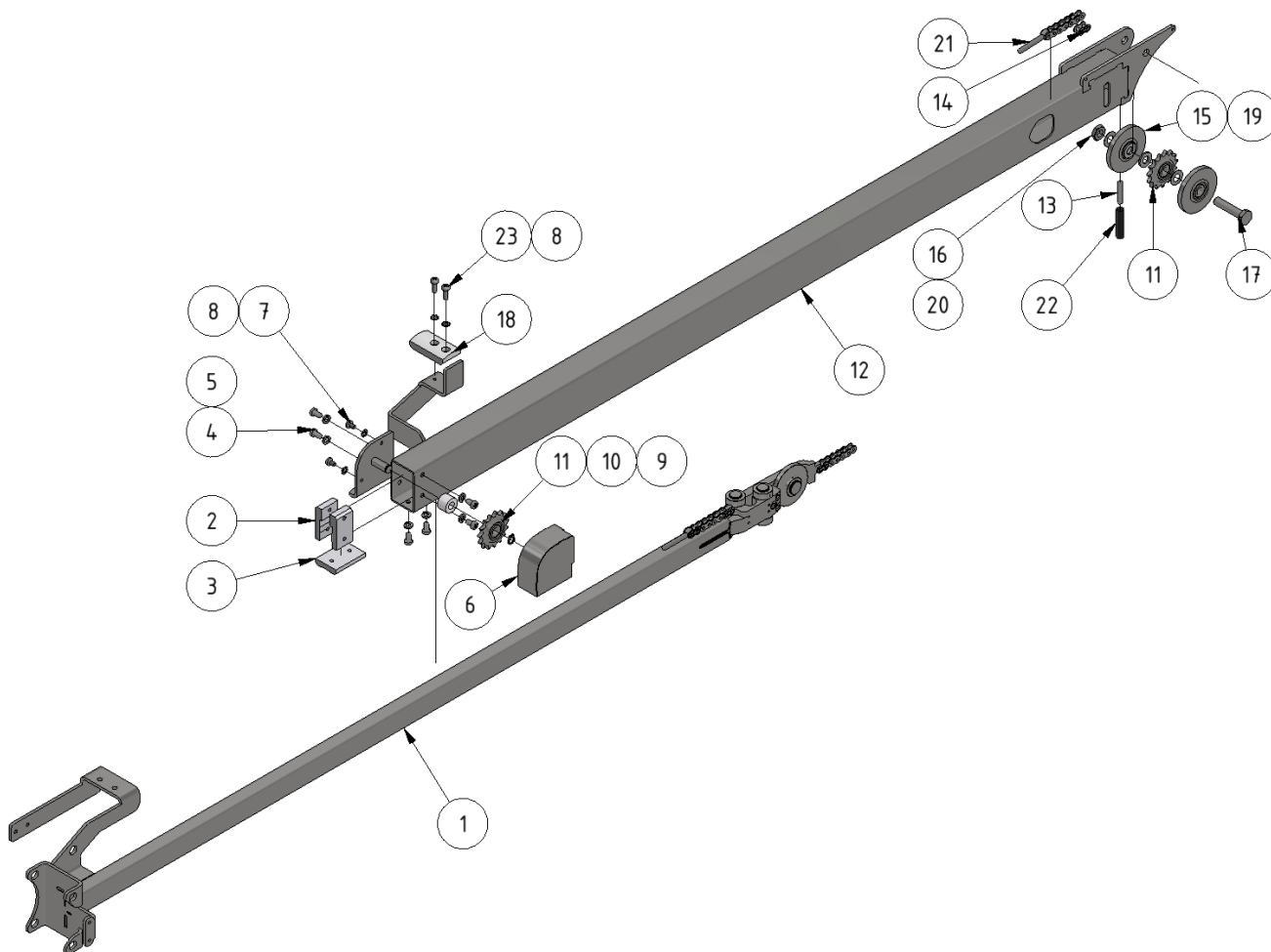



Middle boom assembly

Part number: 1109715

Part of [Telescope assembly](#)



ITEM	DESCRIPTION	PART NUMBER	QTY
1	Inner boom	 1109701	1
2	Sliding plate	1409707	2
3	Narrow sliding plate	1401005	1
4	Screw M6 x 10	941007	6
5	Spring Washer M6	941045	6
6	Cover	1101052	1
7	Screw M5 x 8	941035	2
8	Washer M5 teeth	941087	4
9	Lock ring SGA 10	941041	1
10	Spacer	1401006	1
11	Chain wheel	 1101163	2
12	Middle boom	1109604	1
13	Magnet	904011	1

ITEM	DESCRIPTION	PART NUMBER	QTY
14	Chain lock 3/8	901104	1
15	Roller wheel	 1101197	2
16	Nut M10 low	941095	1
17	Screw M10 x 45.5 low	941094	1
18	Sliding plate	1409701	1
19	Washer M10	941022	2
20	Shims 10 x 0.5	931034	2
21	Chain 127	 1109727	1
22	Shrink tube 9 mm	45518	1
23	Screw M5 x 15	949206	2

From:
<https://wiki.envirologic.se/> - **Envirologic Support Wiki**

Permanent link:
<https://wiki.envirologic.se/doku.php/service:spl:1109715-2?rev=1601280714>

Last update: **2020/09/28 01:11**

